

BS5839
PART 1:2002 +
A2:2008

Fike[®]

THE RELIABLE FIRE PROTECTION SYSTEM YOU CAN COUNT ON.

A conventional fire alarm system is often the natural choice for smaller applications or where budget constraints exist. Fike's TWINFLEX two wire fire alarm system is cost-effective and adaptable to a variety of applications, big or small ... making it one of the most flexible products on the market.

THE INNOVATIVE TWINFLEX, 2-WIRE PANEL IS SUITABLE FOR A VARIETY OF INSTALLATIONS.

This versatile fire alarm panel incorporates Fike's Multipoint detection system using smoke and heat detectors with built-in sounder, allowing the whole system to be installed using only one pair of wires.

That means easier, faster installations AND cost savings.

- Ability to differentiate between callpoint or detector alarms
- All devices have built-in, end-of-line monitoring function
- 7 modes of detection
- Checkpoint alarm verification feature
- Up to 32 devices per zone
- Available in 2, 4, and 8 zone panels
- Allows detectors and sounders to be installed on the same pair of wires

TWINFLEX PROTECTS:

- Schools
- Nursing Homes
- Bed and Breakfasts
- Hotels
- Apartments/Flats
- Restaurants
- Retail Stores
- Shopping Malls
- Museums
- Condominiums
- Industrial Facilities
- Office Buildings
- Warehouses

FIRE ALARM AND DETECTION SYSTEMS ARE CATEGORISED IN THE FOLLOWING WAY:

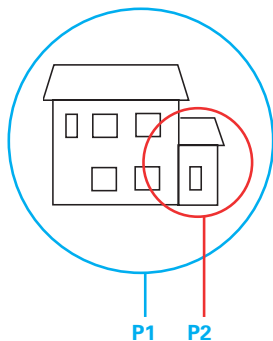

-
- P AFD* designed to primarily protect Property
- P1 AFD installed throughout all areas
- P2 AFD installed only in defined areas
-

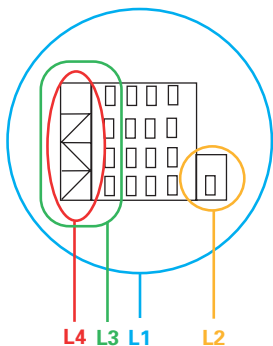

-
- L AFD designed to primarily protect Human Life
- L1 AFD installed throughout all areas
- L2 AFD installed in defined areas in addition to L3
- L3 AFD installed in escape routes and rooms opening onto these routes
- L4 AFD installed in escape routes comprising circulation areas and spaces such as corridors and stairways
- L5 A non-prescriptive system in which the protected area(s) is designed to satisfy a specific fire risk objective (other than that of L1 to L4)
- M System designed to be operated manually (no AFD)
-

*AFD = Automatic Fire Detection

This booklet is a guide to BS5839 part 1
All designs are based on a site specific
written risk assessment.



65dB(A)
@ 500Hz to 1000Hz

Background noise



+5dB(A)
@ 500Hz to 1000Hz

The minimum sound level of a sounder device should be 65dB(A) or 5dB(A) above a background noise which is louder than 60dB(A) (if lasting more than 30 seconds) and at a frequency of between 500Hz and 1000Hz. The maximum sound level should not be greater than 120dB(A) at any normally accessible point. May be reduced to 60dB(A) in stairways, enclosures up to 60m² and specific points of limited extent.

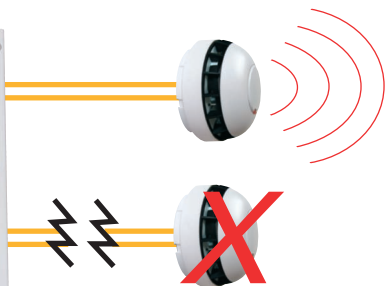

Sounder device cabling should be arranged so that in the event of a fault at least one sounder will remain operational during a fire condition.

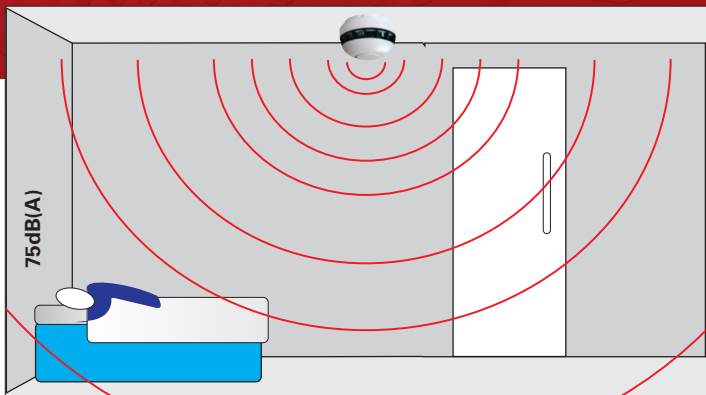

For areas where people are sleeping, sounder devices should produce a minimum of 75dB(A) at the bed-head with all doors shut.

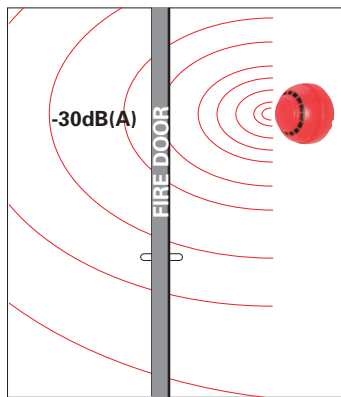
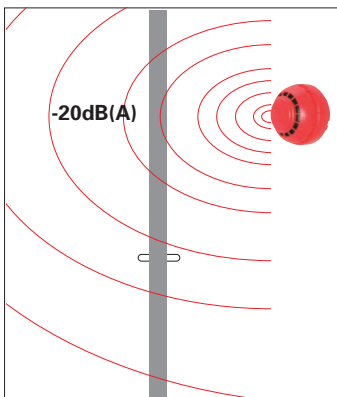

Decibel loss occurs through doors: approximately -20dB(A) through a normal door, and approximately -30dB(A) through a fire door.

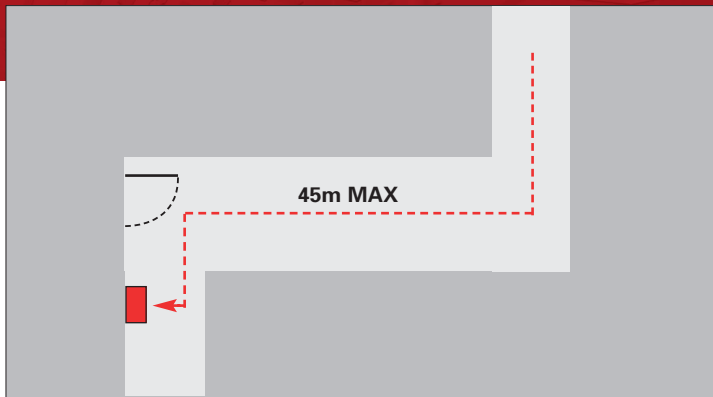

A person should not have to travel more than 45m along an escape route to reach a Manual Call Point. (If a significant proportion of occupants have limited mobility or rapid fire development is likely, this distance should be reduced to 25m). Manual Call Points should be sited at all stair wells and exits from the building, in well illuminated and conspicuous positions free from any potential obstruction.

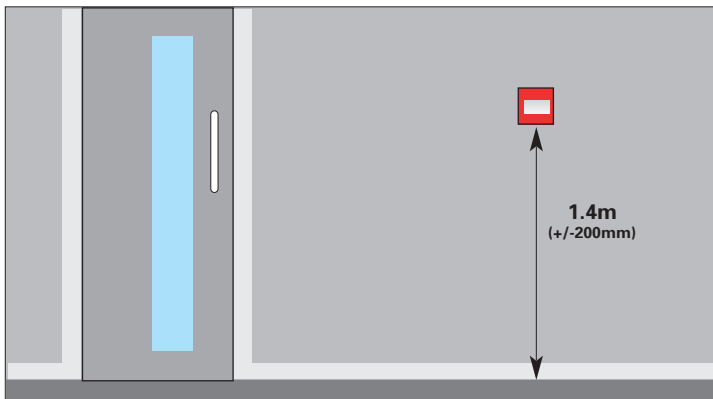

Manual call points should be positioned at a height of 1.4m (+/- 200mm) from floor level. Any non-mechanically protected cable medium should have additional protection up to a height of 2m from floor level.

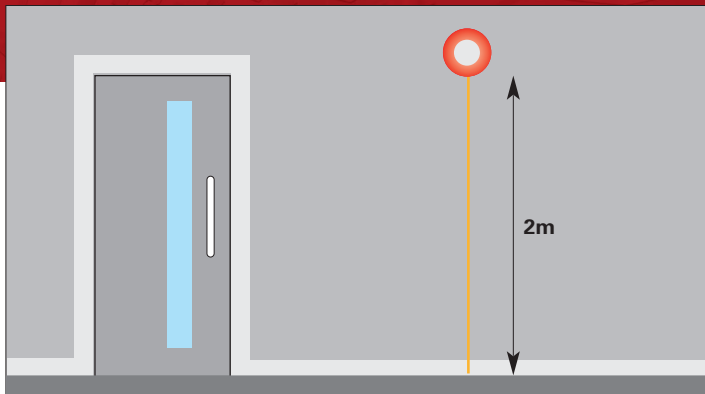

Unless MICC cable is used, all cabling should be mechanically protected from floor level up to a height of 2m.

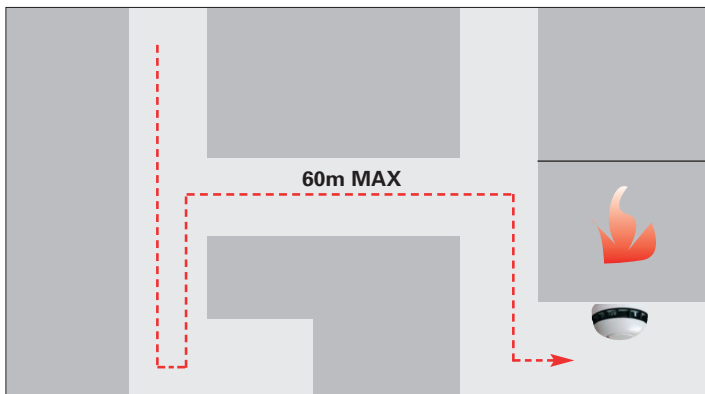

A person searching a Zone for a fire should not have to travel more than 60m to identify the source of a fire.

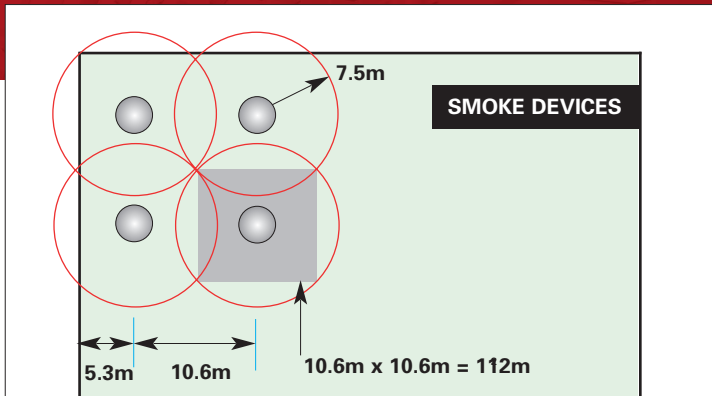

Smoke detection devices have an individual coverage of 7.5m radius. However these radii must overlap to ensure there are no 'blind spots'. Therefore the individual coverage can be represented by a square measuring 10.6 x 10.6m giving an actual area coverage of 112m² per device.

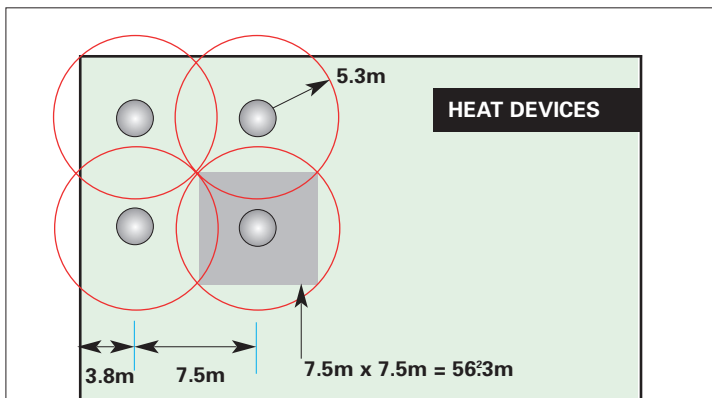

Heat detection devices have an individual coverage of 5.3m radius. However these radii must overlap to ensure there are no 'blind spots'. Therefore the individual coverage can be represented by a square measuring 7.5 x 7.5m giving an actual area coverage of 56.3m² per device.

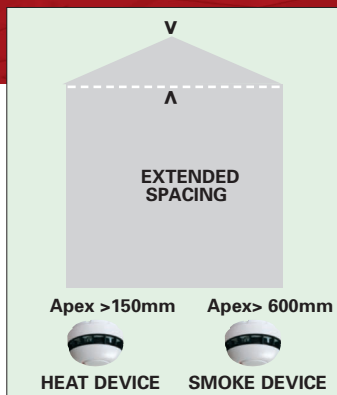
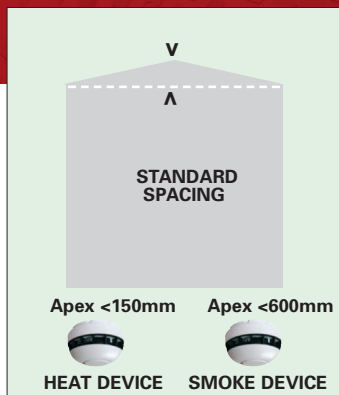

For ceilings that feature a apex: as long as the height of the apex from the rest of the ceiling is less than 150mm for Heat detectors or less than 600mm for Smoke detectors then these can be treated the same as flat ceilings. For higher apexes, a device should be installed at the highest point. The distance to adjacent devices can be increased by 1% per degree of angle of the roof up to a maximum of 25%.

Detector type	Ceiling heights (m)			
	General limits		Rapid attendance	
Heat detectors BS EN 54-5 grade 1				
Class 1	9.0	13.5		
Other Classes	7.5	12.0		
Point smoke detector	10.5	15.0		
Aspirating smoke Detection systems (category 1)	Normal	10.5	Normal	15.0
	Enhanced	12.0	Enhanced	17.0
	Very high	15.0	Very high	21.0
Optical beam smoke detectors BS5839: part 5	25.0		40.0	

Limits of Ceiling Heights

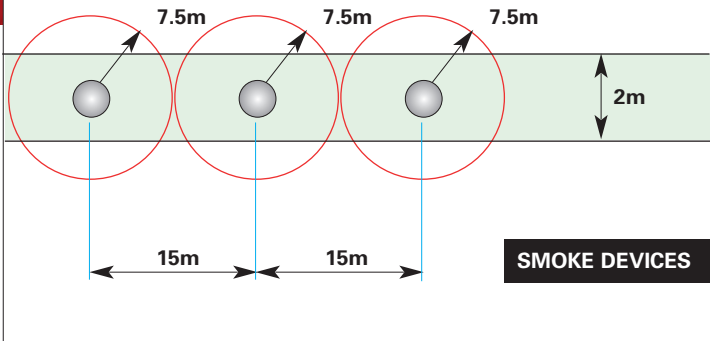

In corridors less than 2m wide the horizontal spacing of detectors may be increased, the areas of coverage need not overlap in the case of a room. Any corridor over 2m wide is deemed a room and device spacing should follow the standard for rooms (see page7).

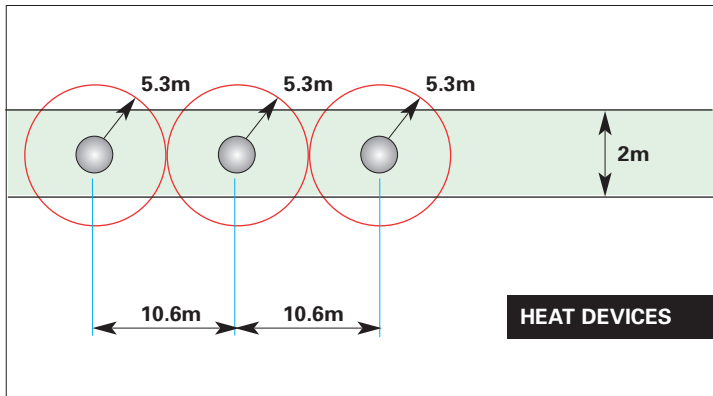

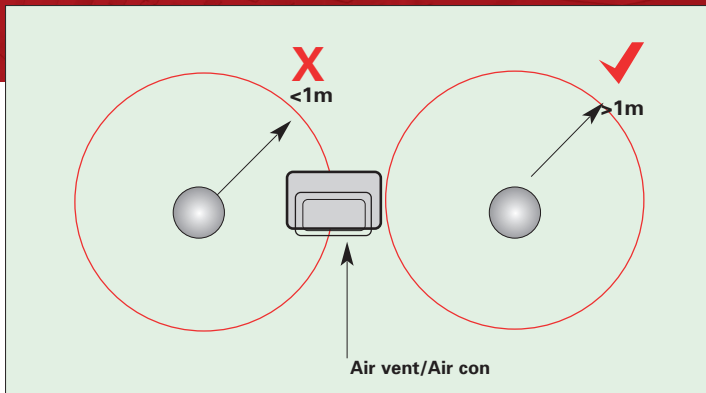

Don't site detectors less than 1m from air Inlets or air conditioning units.

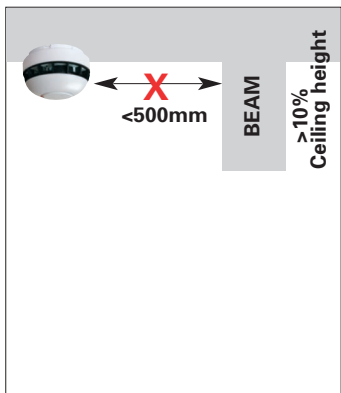
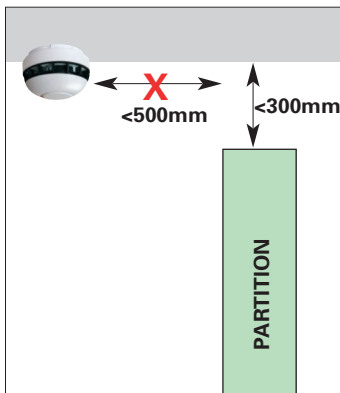

A device should not be mounted within 500mm of any obstruction. If the top of a solid partition is less than 300mm from ceiling then treat it as a wall. Similarly, ceiling obstructions such as beams should be treated as walls if deeper than 10% of the ceiling height.

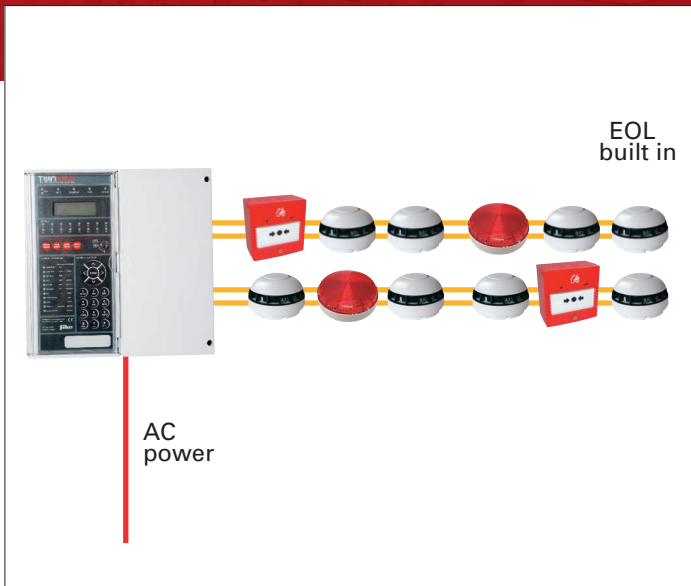

Fire resistant cabling is now required within the whole fire alarm system including the mains supply cables. The use of non-fire resisting cables whether mechanically protected by fire-resisting construction or not, will no longer comply with BS5839.

To avoid mechanical damage and electro magnetic interference, fire alarm cables should not be installed in the same conduit as the cables for other services. Where fire alarm cables share common trunking, a compartment of the trunking, separated from other compartments by a strong, rigid and continuous partition reserved solely for fire cables should be implemented.

With the Twinflex system, separate sounder units are not required as each zone incorporates a sounder unit.

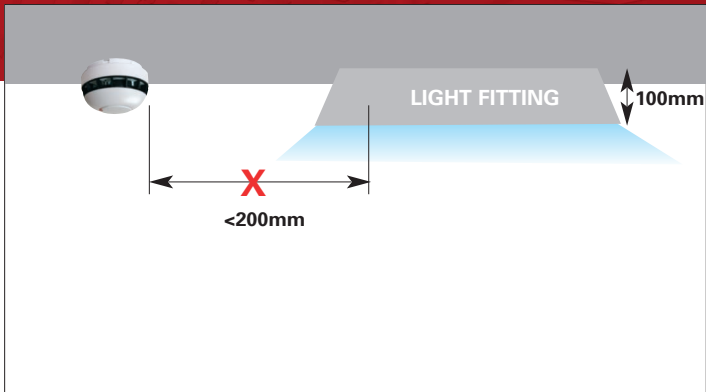

Never mount devices closer than twice the depth of light fittings.

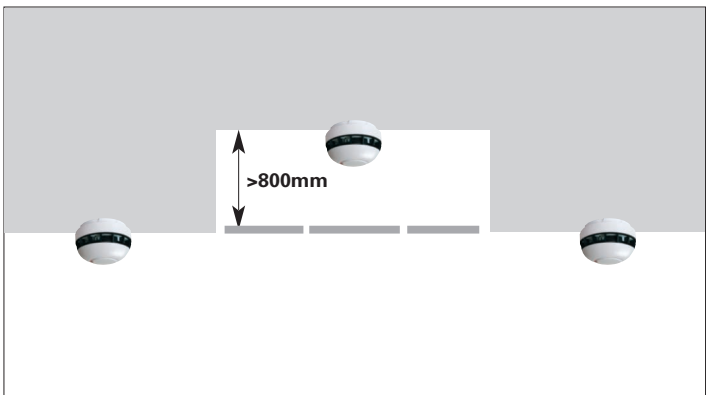

Voids less than 800mm in height need not have independent coverage, unless fire or smoke is able to spread from one area to another through the void or risk assessment shows AFD (Automatic Fire Detection) to be necessary.

LIFT SHAFTS

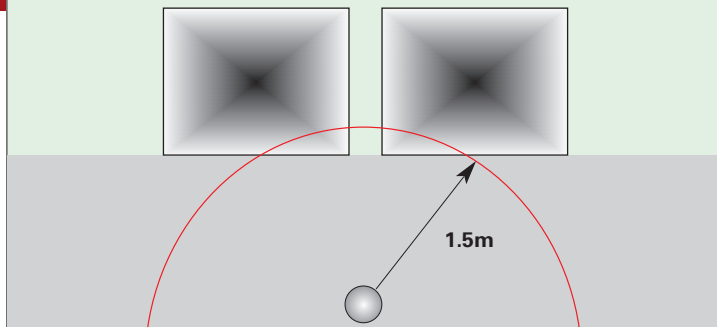

Vertical shafts like lifts and stairways should have a device mounted within 1.5m of any opening.

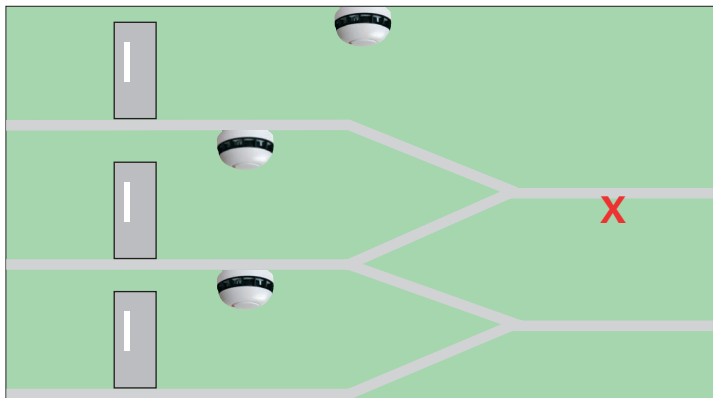

Enclosed stairways should have a detector on each main landing.

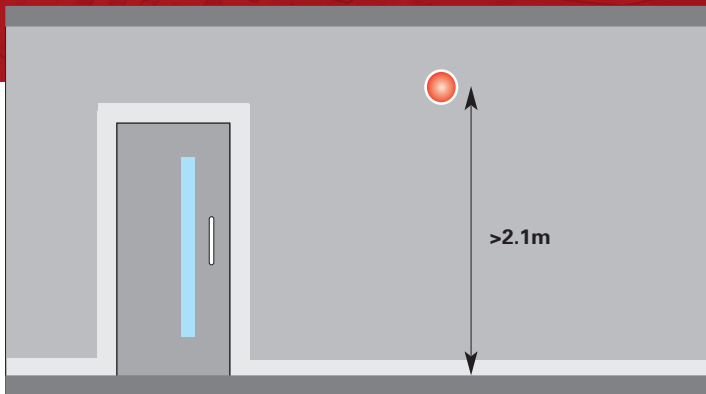

Visual alarms such as strobes should always be mounted above 2.1m from floor level.

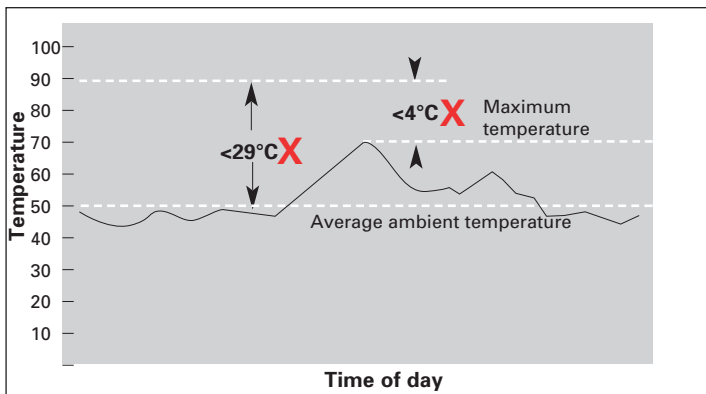

The minimum static response of heat devices should not be less than 29°C above the average ambient temperature, or less than 4°C above the highest temperature the device can be expected to experience.

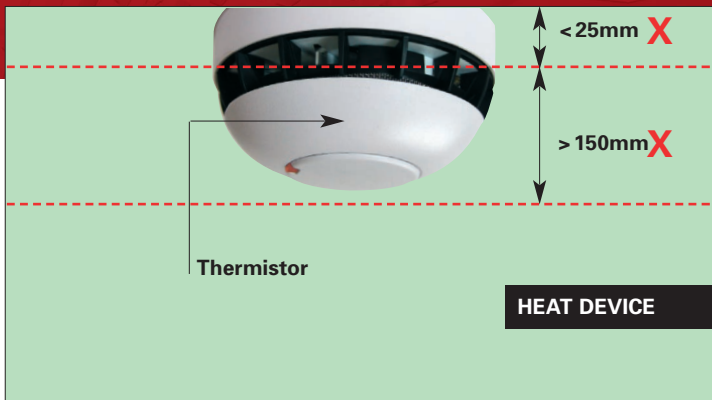

The sensing element of a Heat detection device (thermistor) should not be less than 25mm below ceiling, and not greater than 150mm below ceiling.

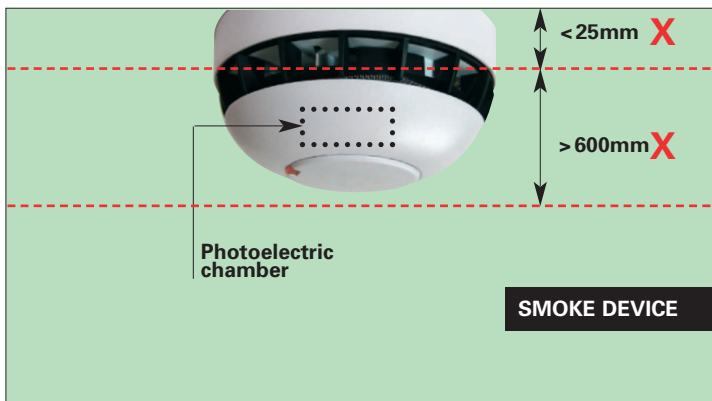

The sensing element of a Smoke detection device (photoelectric smoke chamber) should not be less than 25mm below ceiling, and not greater than 600mm below ceiling.





FIKE GLOBAL MANUFACTURING, SALES AND SERVICE

EUROPE

FIKE SAFETY TECHNOLOGY

Cwmbran, United Kingdom
Tel: +44-0-1633-865558
Email: fstinfo@fike.com

ASIA

FIKE ASIA PACIFIC SDN BHD

Selangor Darul Ehsan, Malaysia
Tel: +60-3-7859-1462
Email: fikeap@fike.com

AMERICAS

FIKE CORPORATION

Blue Springs, MO, USA
Tel: +1-816-229-3405
Email: fpssales@fike.com

MIDDLE EAST

FIKE MIDDLE EAST SPC

Kingdom of Bahrain
Tel: +973-1758-3285
Email: sales@fike.com.bh

FIKE LATINA LTDA (MERCOSUR)

Jundiai, Brazil
Tel: +55-11-4525-5900
Email: vendas@fike.com.br

CARIBBEAN, CENTRAL, SOUTH AMERICA (CCSA)

Houston, TX, USA
Tel: +1-281-895-8342
Email: ccsasales@fike.com

Fike®